

SKIRTING BOARDS





**WE CREATE
WE TEST
WE PRODUCE**

Innovation, quality and know-how. Since 1994 we've been investing in knowledge, technology and our machinery park.

We aim to become market LEADER wherever we are present. We are pushing forward and strive for more to deliver accessories perfectly matched to the products.



TECHNOLOGY

Our inhouse laboratory is testing hundreds of floors from all major manufacturers to improve our accessories and create a functional flooring system. That's why we know the strongest and weakest points of all types of floors. We are also testing our underlays to deliver top quality solutions for different floor types.

DESIGN

Every year A.DESIGN STUDIO analyzes trends, changes in consumer preferences and hundreds of new floor colors. That's why we can create customer orientated solutions and stay relevant.

INNOVATION

We are an European leader in the production of floor accessories. We offer advanced and innovative products. We are pushing the flooring industrie forwards for the more effective, ecological and durable solution.



MADE IN EUROPE

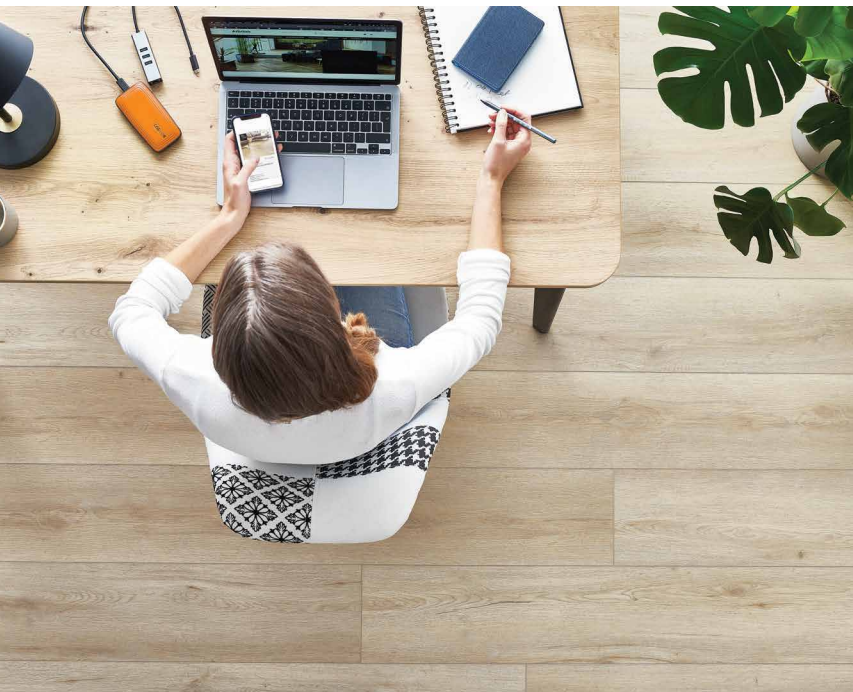
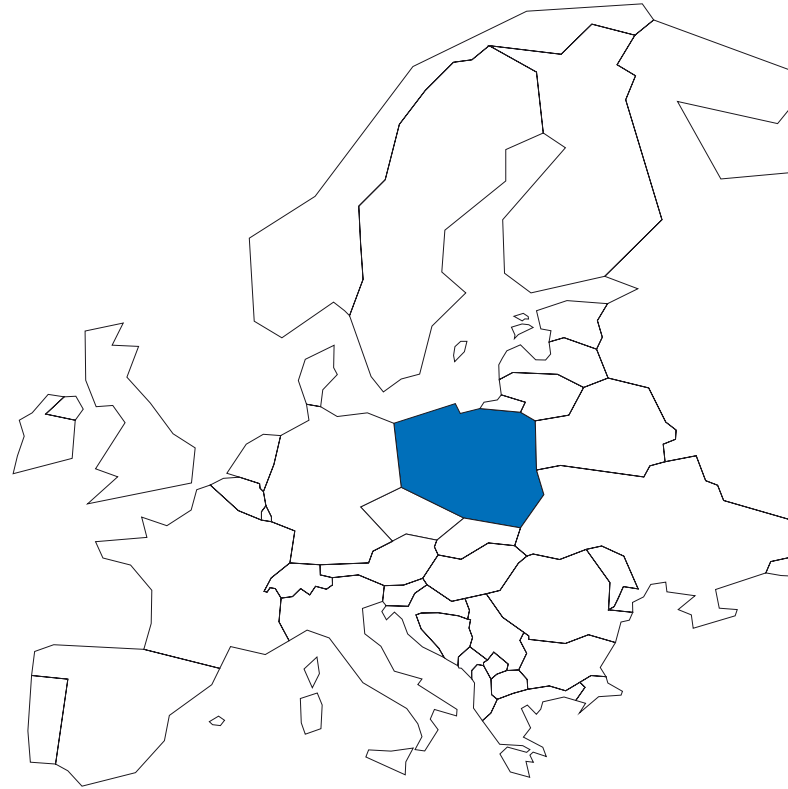

INDO MONOCOLOR | 221 Black Lacquere



INDO MONOCOLOR | 01 White Lacquere



NEW COLLECTIONS

We do not limit ourselves and stop pushing towards innovation. That is what drives us to create new products. Initially we have set an ambitious goal for our new skirting board.



INDO MONOCOLOR ●

3 new colors

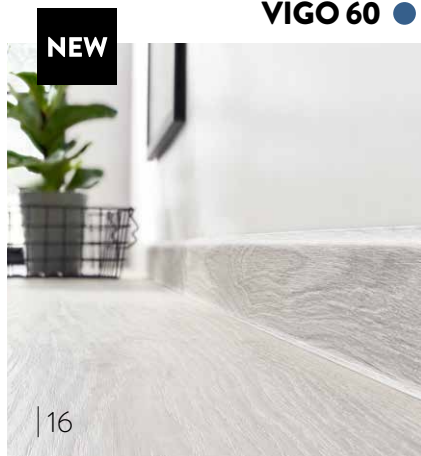

6 new colors

| 16

VIGO 60 ●

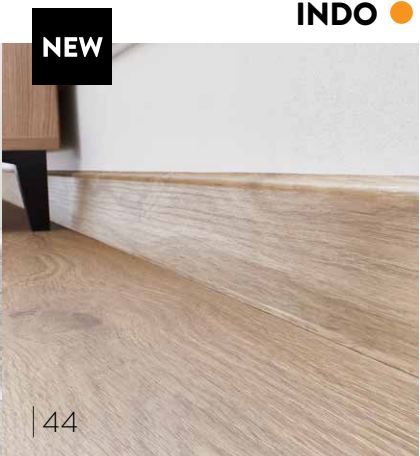

6 new colors

| 44

INDO ●

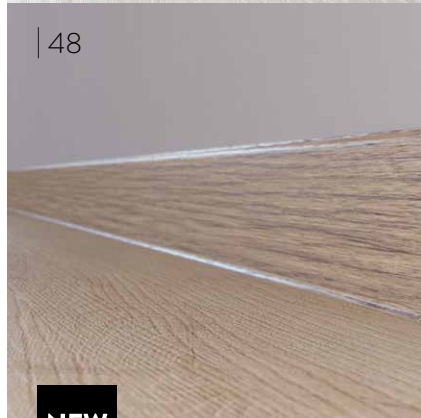

3 new colors

| 48

LARS ●



2 new colors

| 50

MACK ●

TABLE OF CONTENT

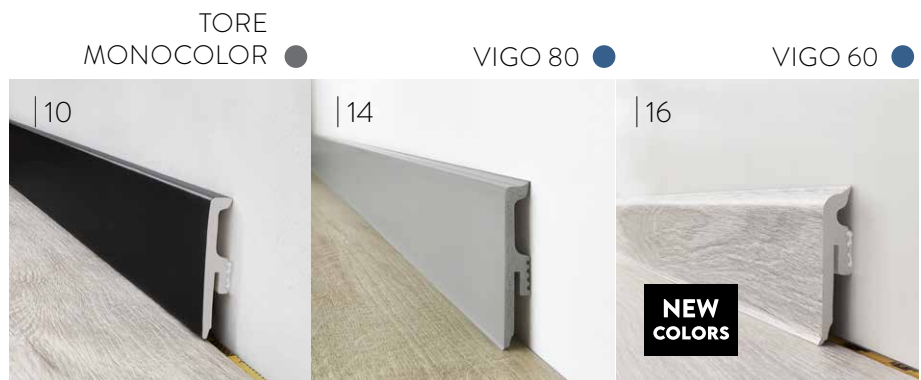

SOLID CORE



NON-PVC WATERPROOF

INDO
MONOCOLOR ●



INDO ●



LARS ●



MACK ●



MODERN PVC

LM60 ●



LM55 ●



TRADITIONAL PVC

PAINT-IT ●



DIAMOND ●



TRADITIONAL MDF

UNIVERSAL PROFILES



ACCESSORIES

SKIRTING BOARDS

SOLID CORE
COLLECTIONS





TORE MONOCOLOR
VIGO 60
VIGO 80

SOLID
CORE



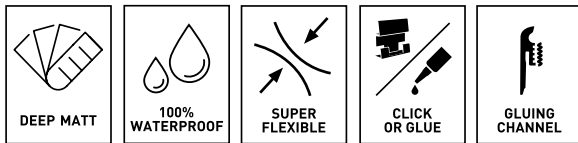

TORE MONOCOLOR

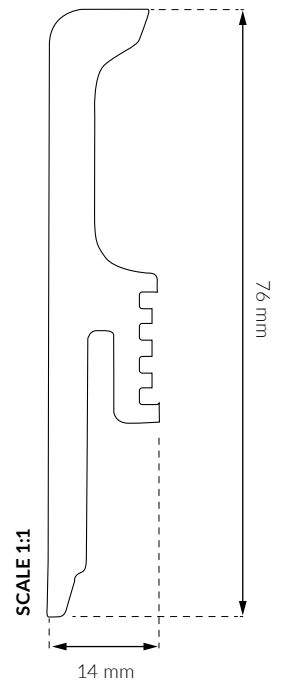

- SOLID CORE SKIRTING BOARD
- DEEP MATT SURFACE
- 100% WATERPROOF SKIRTING BOARDS
- FLEXIBLE CORE, PERFECT FOR ANY KIND OF WALL
- INSTALLATION WITH GLUE OR CLIPS
- GLUING CHANNEL



	SKIRTING	STRONGMAN GLUE	CLIPS AND DOWELS
	220 cm	-	ø 6 mm
	-	1 pc	20 pcs
	22 m	12 pcs	1200 pcs
EAN		5905167788264	5905167826737



01 | White (RAL 9003)

TORE 80 | 5905167845905



05 | Black (RAL 9011)

TORE 80 | 5905167845912



PROTECTIVE FOIL

Protective foil removable after renovation



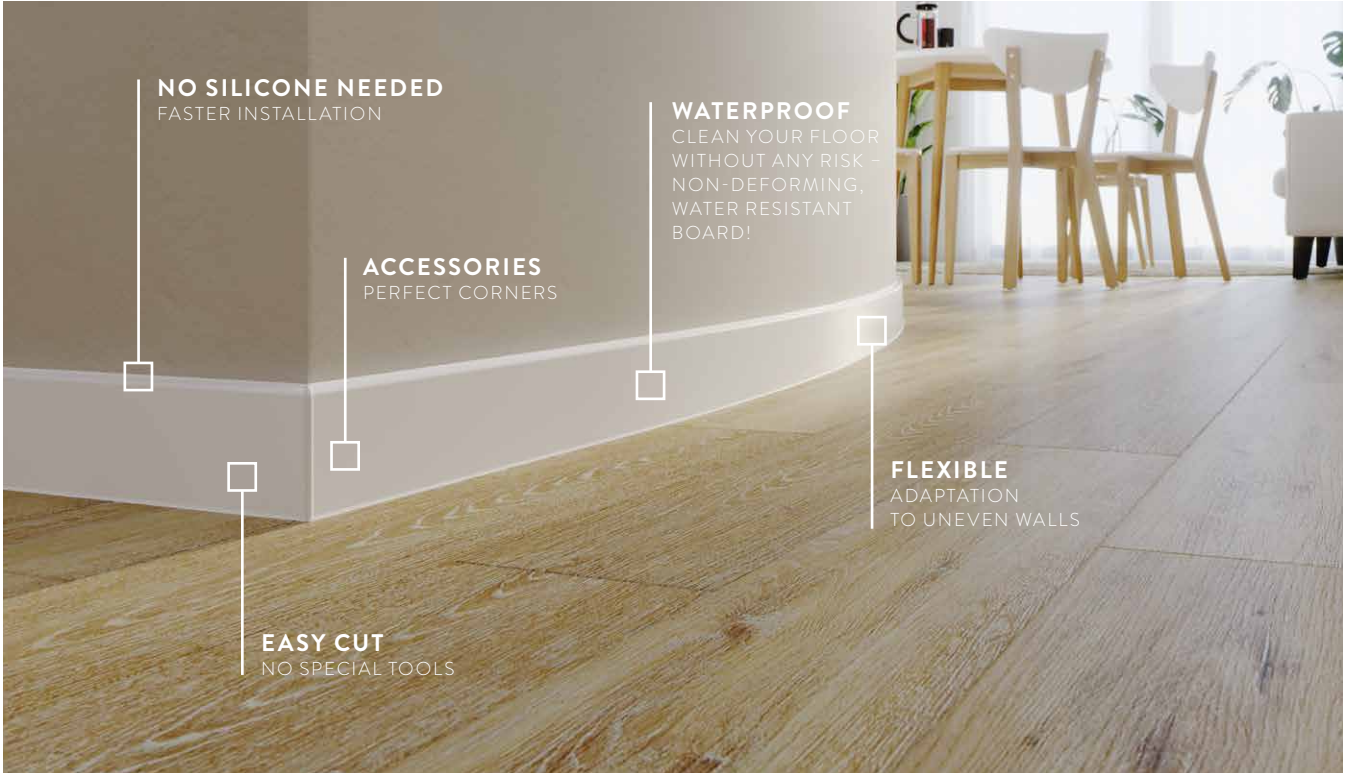

NO SILICONE NEEDED
FASTER INSTALLATION

WATERPROOF
CLEAN YOUR FLOOR
WITHOUT ANY RISK –
NON-DEFORMING,
WATER RESISTANT
BOARD!

ACCESSORIES
PERFECT CORNERS

FLEXIBLE
ADAPTATION
TO UNEVEN WALLS

EASY CUT
NO SPECIAL TOOLS



VIGO

SOLID CORE SKIRTING BOARDS

IT IS TIME TO END WITH DIFFICULT CHOICES.
Thanks to our solutions we've created a skirting board
in hybrid technology. Now, you have high quality
surface of lacquered MDF skirtings and the flexibility
and waterproofness of PVC skirtings.

What else?

Easy assembly and dirt resistance. Thanks to the additional flexible and integrated seals, we have waterproof barrier on two sides - from the wall and from the floor.

LET'S TAKE A STEP
INTO THE FUTURE.
LET'S VIGO



VIGO 80



- HYBRID TECHNOLOGY
- NO NEED FOR SILICONE
- FLEXIBLE AND DURABLE
- PROTECTIVE LAYER
- WATERPROOF AND DIRT RESISTANCE
- QUICK INSTALLATION
- GLUING CHANNEL

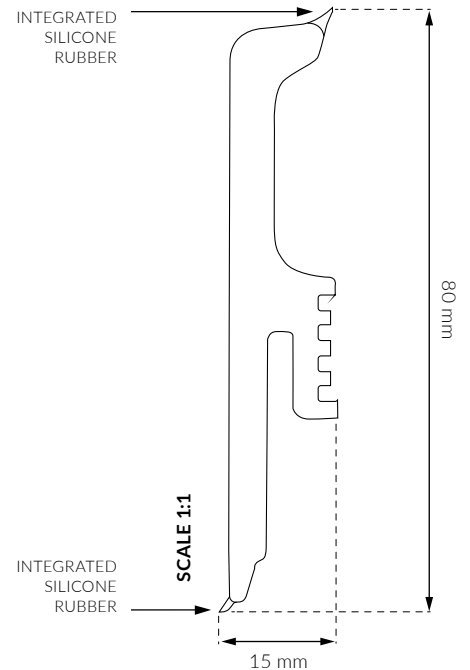

SKIRTING



STRONGMAN GLUE



CLIPS AND DOWELS



ACCESSORIES



EAN

220 cm	-	ø 6 mm					
-	1 pc	20 pcs	2 pcs	2 pcs	2 pcs	1L + 1R	
22 m	12 pcs	1200 pcs	30 pcs	30 pcs	30 pcs	30 pcs	

5905167788264

5905167826737



01 | White | RAL 9003
 SKIRTING | 5905167826478
 CS PROFILE | 40



03 | Dark Gray | RAL 7042
 SKIRTING | 5905167826492
 CS PROFILE | A1



PROTECTIVE FOIL
 Protective foil removable
 after renovation

PERFECT CORNERS



CUTTING METHODS OF CORNERS



MANUAL CUTTING
 The possibility of cutting
 corners with a hand saw



MITRE SAW
 The possibility of cutting
 corners with a mitre saw



VIGO 60

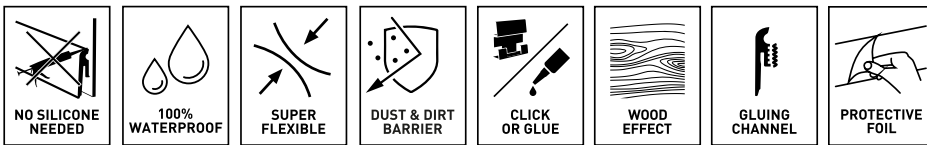

- HYBRID TECHNOLOGY
- NO NEED FOR SILICONE
- FLEXIBLE AND DURABLE
- PROTECTIVE LAYER
- WATERPROOF AND DIRT RESISTANCE
- QUICK INSTALLATION
- GLUING CHANNEL

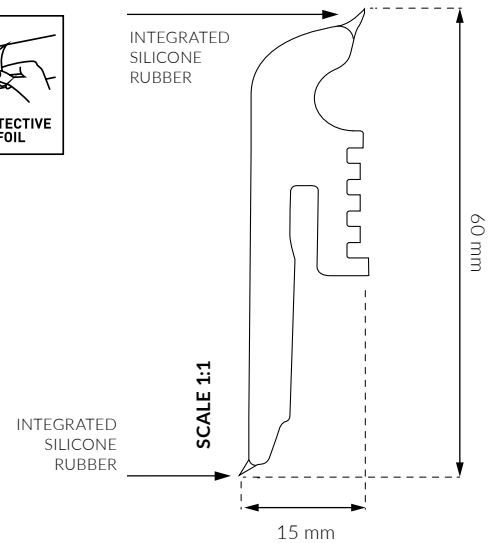

SKIRTING



STRONGMAN GLUE



CLIPS AND DOWELS



ACCESSORIES



EAN

220 cm

-

ø 6 mm

-

1 pc

20 pcs

2 pcs

2 pcs

2 pcs

1L + 1R

22 m

12 pcs

1200 pcs

30 pcs

30 pcs

30 pcs

30 pcs

5905167788264

5905167826737



01 | White | RAL 9003
 SKIRTING | 5905167825679
 CS PROFILE | 40



02 | Gray | RAL 7035
 SKIRTING | 5905167825686
 CS PROFILE | A1



03 | Dark Gray | RAL 7042
 SKIRTING | 5905167825693
 CS PROFILE | 45



04 | Anthracite | RAL 7024
 SKIRTING | 5905167825709
 CS PROFILE | 52



102 | Scandinavian Oak
 SKIRTING | 5905167825716
 CS PROFILE | 19



112 | Bradford Oak
 SKIRTING | 5905167825723
 CS PROFILE | 27



107 | Vermont Oak
 SKIRTING | 5905167825747
 CS PROFILE | 03



158 | Monument Oak
 SKIRTING | 5905167825730
 CS PROFILE | 158



159 | Newport Oak
 SKIRTING | 5905167825754
 CS PROFILE | 159



160 | Calvia Oak
 SKIRTING | 5905167825761
 CS PROFILE | 159



161 | Goldberg Oak
 SKIRTING | 5905167825778
 CS PROFILE | 159



163 | Rossport Oak
 SKIRTING | 5905167825792
 CS PROFILE | 09



154 | Sierra Oak
 SKIRTING | 5905167825822
 CS PROFILE | 47



110 | Jersey Oak
 SKIRTING | 5905167825808
 CS PROFILE | 07



147 | Georgetown Oak
 SKIRTING | 5905167825815



162 | Cornwall Oak
 SKIRTING | 5905167825785
 CS PROFILE | 162



25 | Girona Chestnut
 SKIRTING | 5905167844960
 CS PROFILE | 25



44 | Bolton Oak
 SKIRTING | 5905167844977
 CS PROFILE | 42, 19



16 | Caucasian Oak
 SKIRTING | 5905167844984
 CS PROFILE | 23



22 | Northern Ash
 SKIRTING | 5905167844991
 CS PROFILE | 02



173 | Rodenbach Oak
 SKIRTING | 5905167845004
 CS PROFILE | 158



09 | Manorial Oak
 SKIRTING | 5905167845011
 CS PROFILE | 47



12 | Dark Oak
 SKIRTING | 5905167845028
 CS PROFILE | 12



174 | Porto Oak
 SKIRTING | 5905167845035
 CS PROFILE | 11



188 | Freemont Oak
SKIRTING | 5905167853443
CS PROFILE | 48



177 | Pekkala Oak
SKIRTING | 5905167853450
CS PROFILE | 46



180 | Alba Oak
SKIRTING | 5905167853467
CS PROFILE | 26



187 | Avalon Oak
SKIRTING | 5905167853474
CS PROFILE | 26



184 | Sherman Oak
SKIRTING | 5905167853481
CS PROFILE | 4



191 | Kinesawa Oak
SKIRTING | 5905167853498
CS PROFILE | 26



PERFECT CORNERS

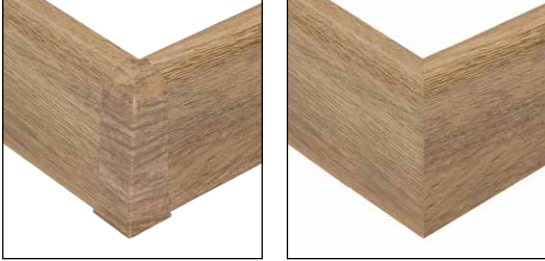

CUTTING METHODS OF CORNERS



MANUAL CUTTING

The possibility of cutting corners with a hand saw



MITRE SAW

The possibility of cutting corners with a mitre saw



SKIRTING BOARDS

NON-PVC WATERPROOF COLLECTIONS

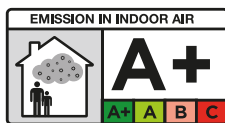

Information sur le niveau d'émission de substances volatiles dans l'air intérieur, présentant un risque de toxicité par inhalation, sur une échelle de classe allant de A+ (très faibles émissions) à C (fortes émissions)



 0%
PHTHALATES



STIQ
AVIA
VEGA
INTEGRA

NON-PVC
WATERPROOF



 100% WATERPROOF	 JUST GLUE	 IMPACT RESISTANT	 PROTECTIVE FOIL	DEDICATED TO VINYL FLOORING & CERAMIC
------------------------	---------------	-------------------------	------------------------	---

- WATERPROOF
- JUST GLUE
- IMPACT RESISTANT
- HOMOGENEOUS MATERIAL (100% PVC FREE)
- NO PAINTS AND LACQUERS
- VOC FREE
- PERFECT FOR RECYCLING
- DEDICATED TO VINYL FLOORING & CERAMIC

	 SKIRTING	 STRONGMAN GLUE	 ACRYLIC
cm /	220 cm	-	-
	-	1 pc	1 pc
	44 m	12 pcs	12 pcs
EAN		5905167788264	5907584890193

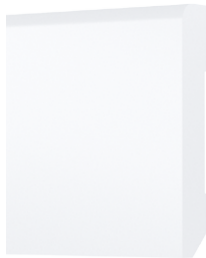
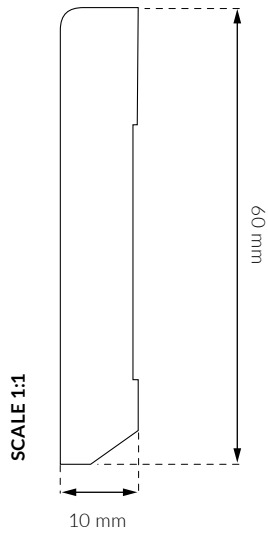

White
S611 | 5905167839997
44 m

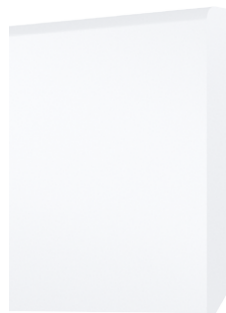
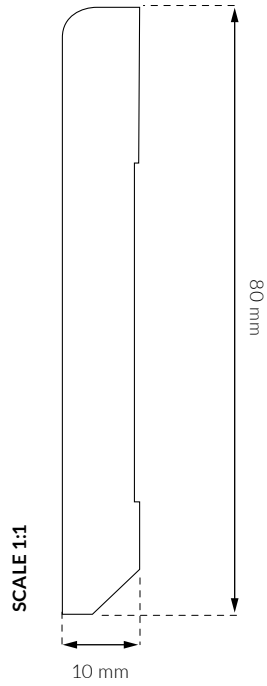

White
S810 | 5905167839850
44 m

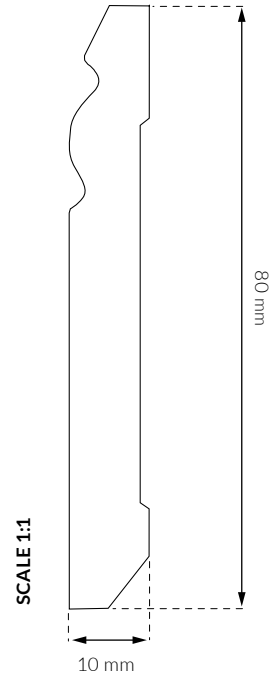

White
S820 | 5905167839867
44 m



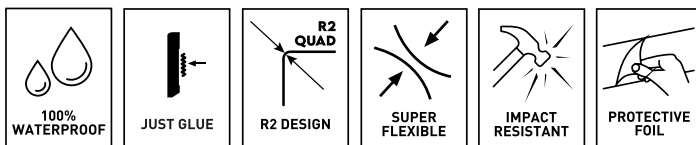

PROTECTIVE FOIL
Protective foil removable
after renovation

STIQ XL



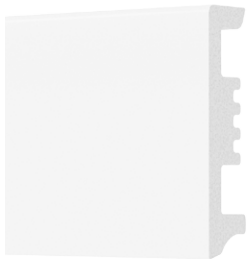
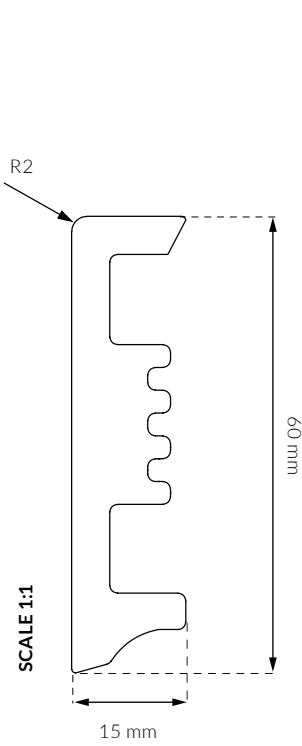

- WATERPROOF
- R2 DESIGN
- JUST GLUE
- SUPER FLEXIBLE
- IMPACT RESISTANT
- HOMOGENEOUS MATERIAL (100% PVC FREE)
- NO PAINTS AND LACQUERS
- VOC FREE
- PERFECT FOR RECYCLING

	SKIRTING	STRONGMAN GLUE	ACRYLIC
	220 cm	-	-
	-	1 pc	1 pc
	44 m	12 pcs	12 pcs
EAN		5905167788264	5907584890193

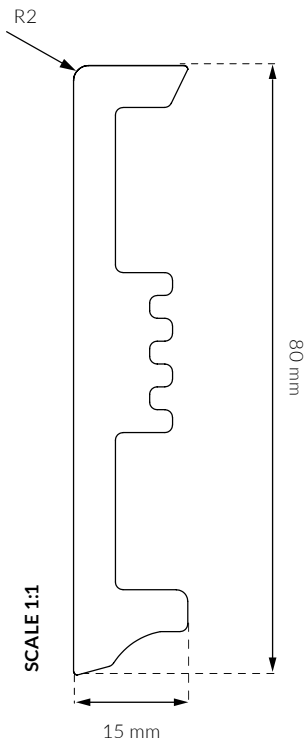

White
 STX610 | 5905167839874
 | 44 m



White
 STX810 | 5905167839881
 | 44 m

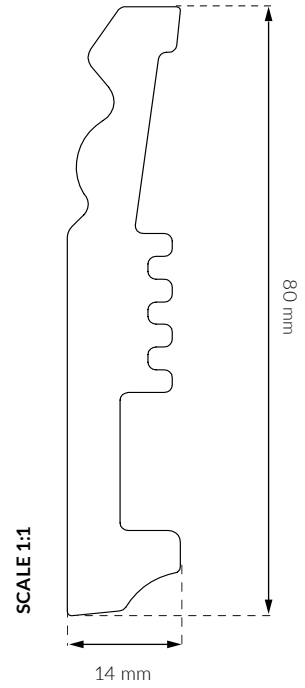

White
 STX820 | 5905167839898
 | 44 m



PROTECTIVE FOIL
 Protective foil removable
 after renovation

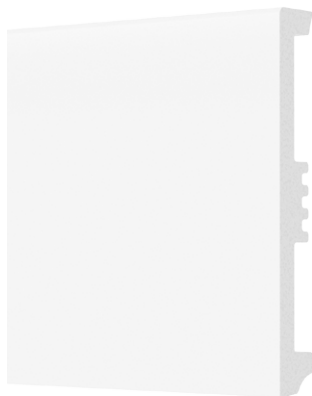
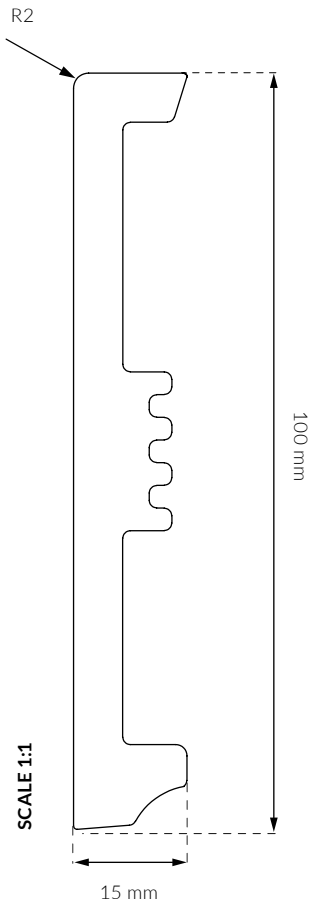

White
 STX110 | 5905167839904
 44 m

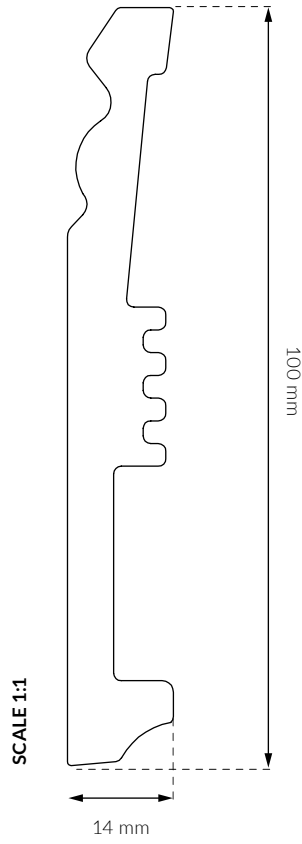

White
 STX120 | 5905167839911
 44 m



PROTECTIVE FOIL



Protective foil
 removable
 after renovation

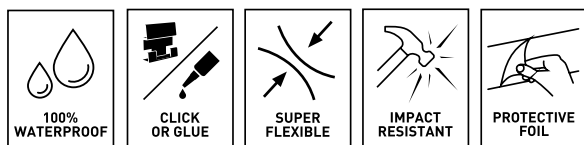

STIQ+



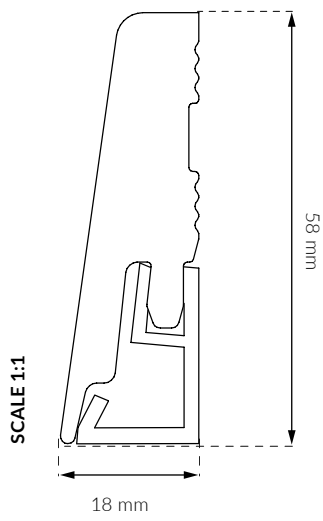

- WATERPROOF
- PERFECT FOR RENOVATION
- JUST GLUE
- SUPER FLEXIBLE
- IMPACT RESISTANT
- HOMOGENEOUS MATERIAL (100% PVC FREE)
- NO PAINTS AND LACQUERS
- VOC FREE
- PERFECT FOR RECYCLING

	SKIRTING	STRONGMAN GLUE	ACRYLIC	CLIPS AND DOWELS	ACCESSORIES			
 220 cm	220 cm	-	-	ø 6 mm	-	-	-	-
	-	1 pc	1 pc	30 pcs	2 pcs / 15 pack	2 pcs / 15 pack	2 pcs / 15 pack	1L + 1R 15 L 15 R
	44 m	12 pcs	12 pcs	840 pcs	-	-	-	-
EAN		5905167788264	5907584890193	5905167839935				

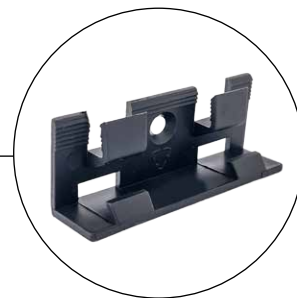

PROTECTIVE FOIL
 Protective foil
 removable
 after renovation



White
 STP580 | 5905167839928
 | 44 m

EAN: 5905167839935
 Details on page: 69

ACCESSORIES



CLIPS AND DOWELS



5905167839942



5905167839959



5905167839973



5905167839966

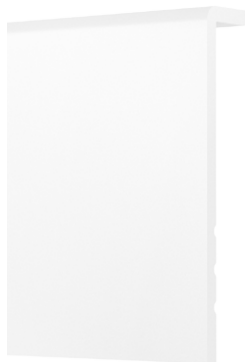
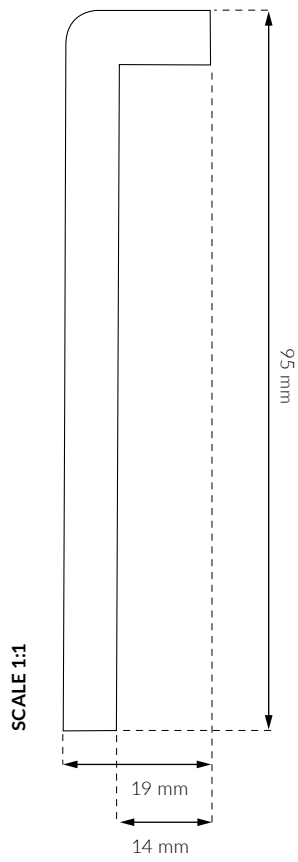

White

STP950 | 5905167839980



44 m



PROTECTIVE FOIL

Protective foil
removable
after renovation





100% WATERPROOF	JUST GLUE	SUPER FLEXIBLE	DUST & DIRT BARRIER	PERFECT FOR ECOMMERCE	DEDICATED TO VINYL FLOORING & LAMINATE
-----------------	-----------	----------------	---------------------	--------------------------	---

- PERFECT FOR ECOMMERCE
- WATERPROOF
- JUST GLUE
- DUST AND DIRT BARRIER
- SUPER FLEXIBLE
- HOMOGENEOUS MATERIAL (100% PVC FREE)
- NO PAINTS AND LACQUERS
- VOC FREE
- PERFECT FOR RECYCLING

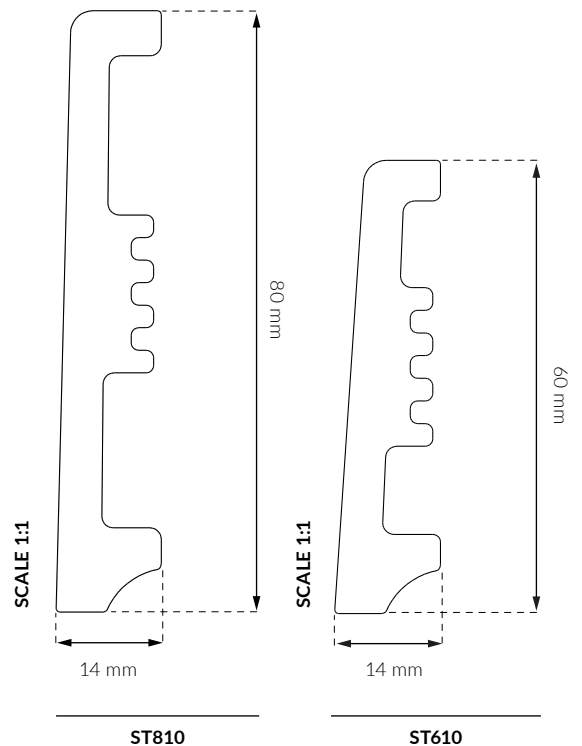

SKIRTING



STRONGMAN GLUE



ACRYLIC

	200cm	-	-
	-	1 pc	1 pc
	20 m	12 pcs	12 pcs
EAN		5905167788264	5907584890193



01 | White

ST610

| 5905167838877



01 | White

ST810







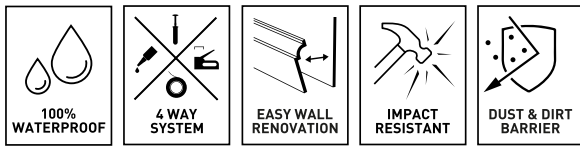
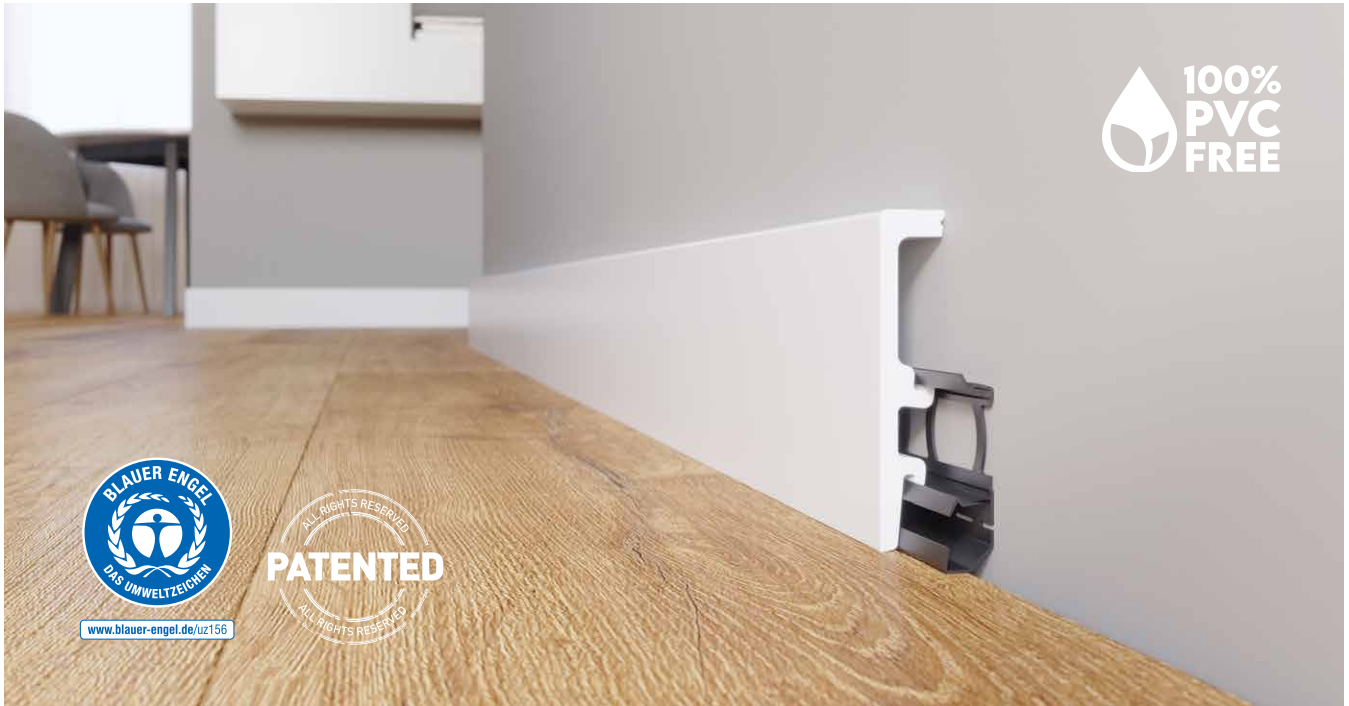

| 5905167838891





VEGA



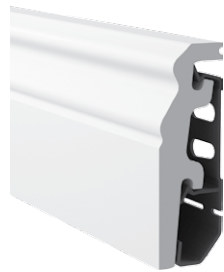
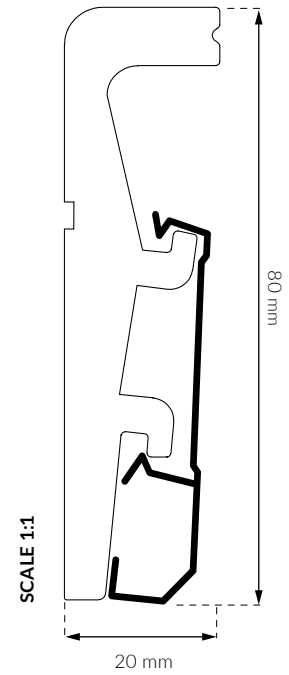
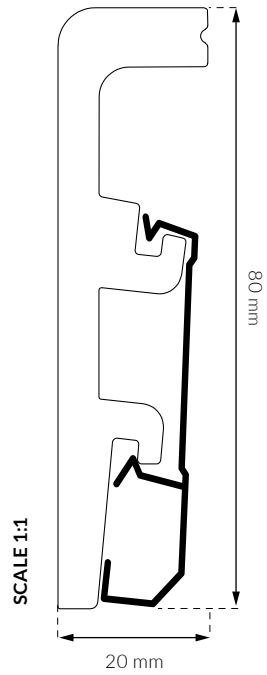
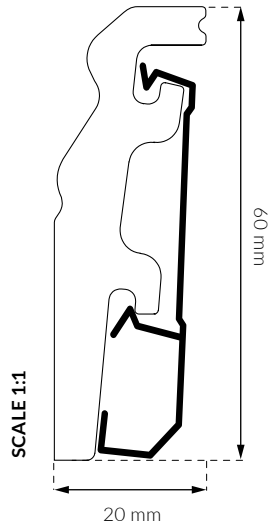
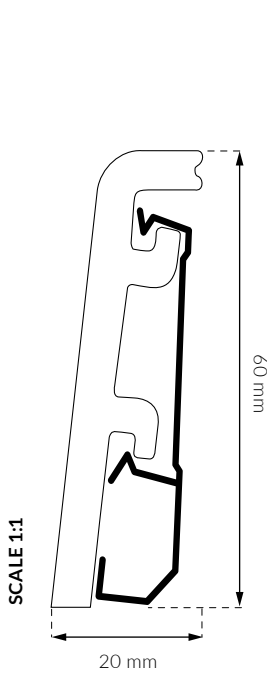

- WATERPROOF
- 4 WAY SYSTEM
- EASY WALL RENOVATION
- IMPACT RESISTANT
- DUST AND DIRT BARRIER
- 100% PVC FREE

	 SKIRTING	 BLOCKS	 STRONGMAN GLUE	 TAPE	 ACRYLIC
	240 cm	2,3x2,3x15,2 cm	-	-	-
	-	4 pcs = 1 set	1 pc	1 pc	1 pc
	24 m / 28,8 m	10 sets	12 pcs	24 pcs	12 pcs
EAN		5905167746844	5905167788264	5905167731444	5907584890193



White
 P0610 | 5905167747926
 24 m

White
 P0620 | 5905167755662
 21,8 m

White
 P0810 | 5905167734551
 24 m

White
 P0811 | 5905167734568
 24 m

ACCESSORIES / UNIVERSAL BLOCK

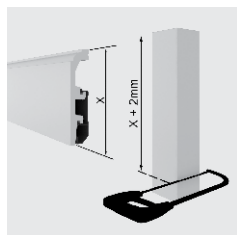
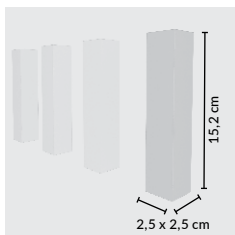

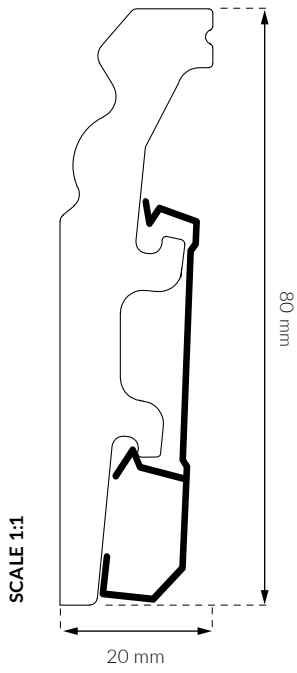

White

P0830 | 5905167755679
 24 m

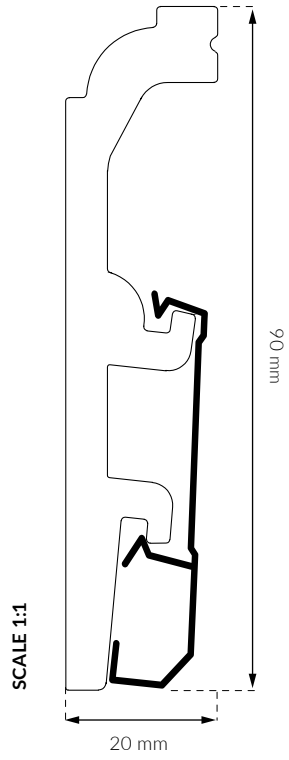

White

P0910 | 5905167734605
 24 m

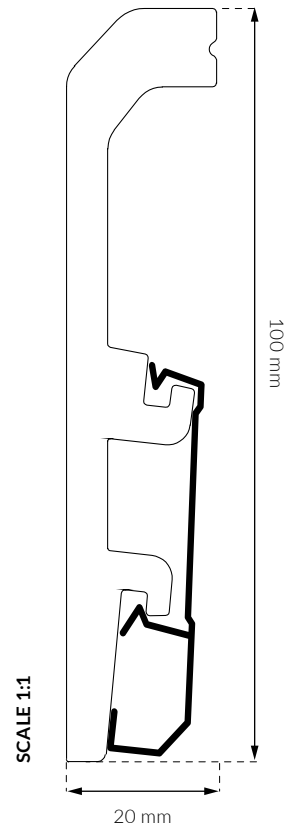

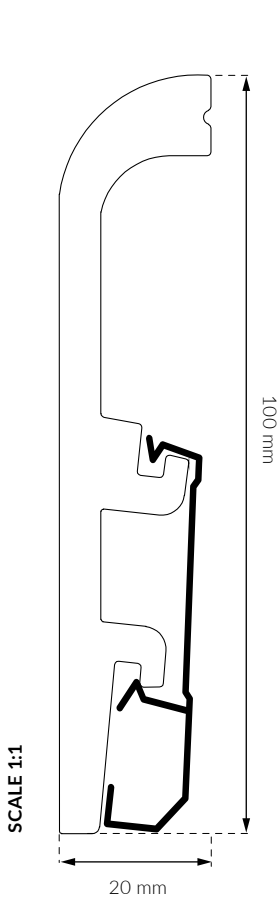

White

P1010 | 5905167734629
 24 m

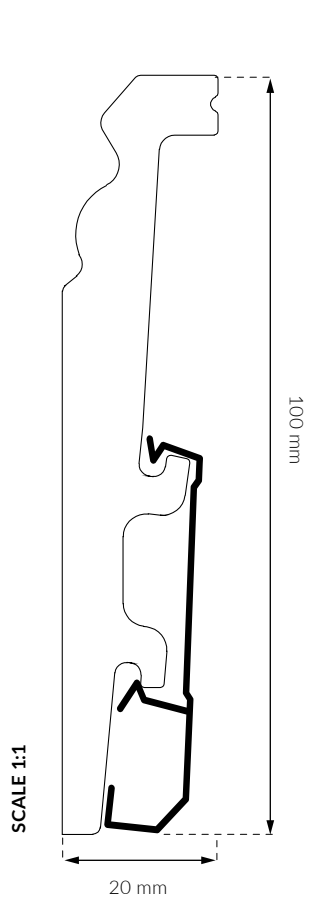

White
 P1020 | 5905167734643
 24 m



White
 P0910 | 5905167734605
 24 m

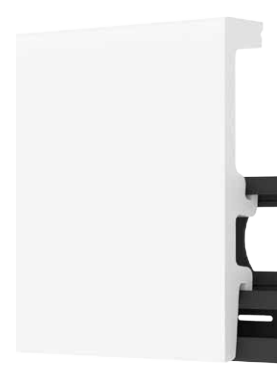
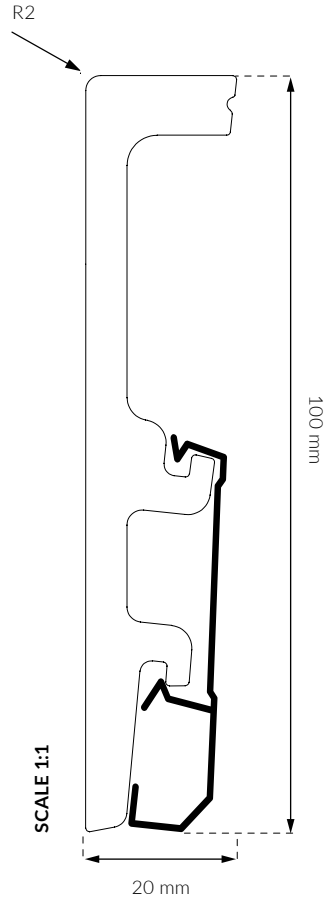

White
 P1040 | 5905167839843
 24 m

INTEGRA

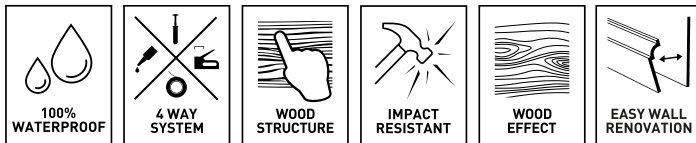

- WATERPROOF
- 4 WAY SYSTEM
- IMPACT RESISTANT
- WOOD STRUCTURE
- IMPACT RESISTANT
- WOOD EFFECT
- EASY WALL RENOVATION
- HOMOGENEOUS MATERIAL (100% PVC FREE)
- NO PAINTS AND LACQUERS
- VOC FREE
- PERFECT FOR RECYCLING

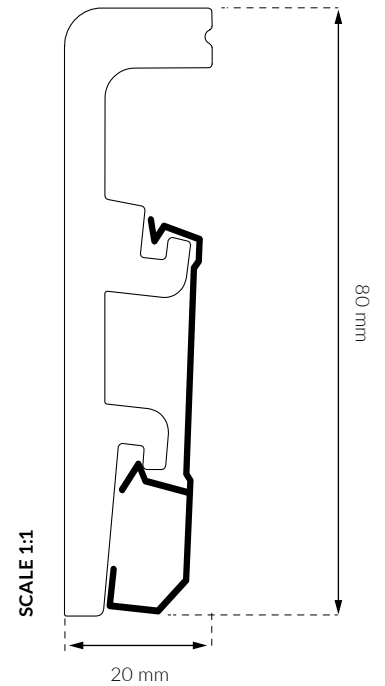

SKIRTING



STRONGMAN GLUE



TAPE

	240 cm	-	-
	-	1 pc	1 pcs
	24 m	12 pcs	24 pcs
EAN	5905167788264	5905167731444	



01 | White
SKIRTING | 5905167734353



02 | Aluminium
SKIRTING | 5905167734360



3 | Snow Ash
SKIRTING | 5905167734377



12 | Roma Oak
SKIRTING | 5905167734469



7 | Alabama Oak
SKIRTING | 5905167734414



14 | Oregon Oak
SKIRTING | 5905167734483



5 | City Oak
SKIRTING | 5905167734391



4 | Northern Ash
SKIRTING | 5905167734384



6 | Alaska Ash
SKIRTING | 5905167734407



11 | Persian Oak
SKIRTING | 5905167734452



46 | Davos Oak
SKIRTING | 5905167838228



44 | Manorial Oak
SKIRTING | 5905167838204



9 | Classic Oak
SKIRTING | 5905167734438



8 | Nevada Oak
SKIRTING | 5905167734421



10 | Calvados Oak
SKIRTING | 5905167734445



19 | Natural Oak
SKIRTING | 5905167734537



18 | Loft Oak
SKIRTING | 5905167734520



17 | Dark Walnut
SKIRTING | 5905167734513



45 | Wenge Africa
SKIRTING | 5905167838211



20 | Borneo Oak
SKIRTING | 5905167734544

SKIRTING BOARDS

MODERN PVC
COLLECTIONS





**INDO
INDO MONOCOLOR
LARS
MACK**

MODERN
PVC

INDO MONOCOLOR

NEW





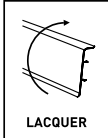

**CLICK
INSTALLATION**



LACQUER



**4 WAY
SYSTEM**



FLEXIBLE

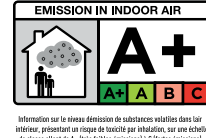



EMISSION IN INDOOR AIR
A+

Information sur le niveau d'émission de substances volatiles dans l'air intérieur, correspondant au risque de toxicité par inhalation, voir une échelle de classe allant de A+ (très faibles émissions) à C (fortes émissions)

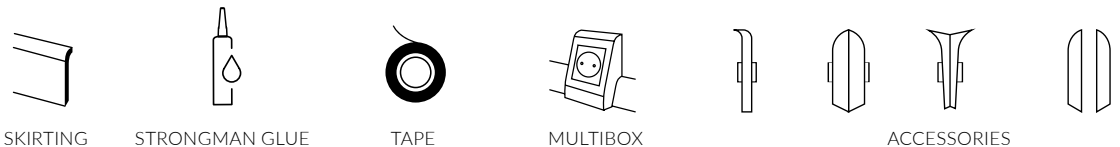
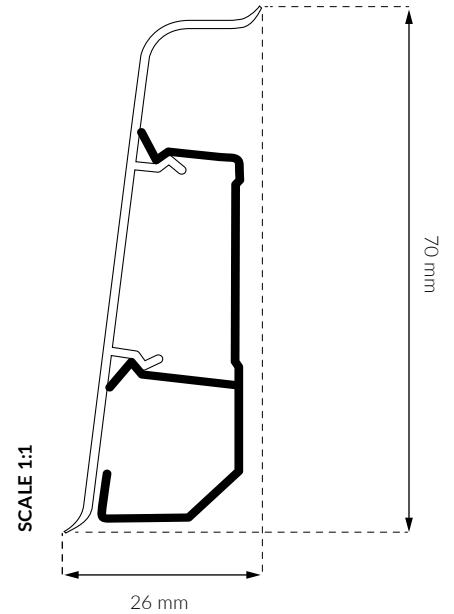
- CLICK INSTALLATION
- LACQUER
- 4 WAY SYSTEM
- FLEXIBLE
- ECO FRIENDLY



	250 cm	-	-	-	-	-	-	-
	-	1 pc	1 pc	1 pc	2 pcs / 20 pack	2 pcs / 20 pack	2 pcs / 20 pack	1L + 1R 20 L 20 R
	25 m	12 pcs	24 pcs	10 pcs	30 pcs / 1440 pack	30 pcs / 360 pack	30 pcs / 360 pack	30 pcs / 720 pack 30 pcs / 720 pack
EAN	5905167788264	5905167731444	5906735698503					



40 I White Mat

SKIRTING | 5905167781685
CS PROFILE | 40



220 I Black Mat

SKIRTING | 5905167853047

LACQUERED
SKIRTING



01 I White Lacquere

SKIRTING | 5905167725719
CS PROFILE | 40

LACQUERED
SKIRTING



221 I Black Lacquere

SKIRTING | 5905167853047

LACQUERED
SKIRTING

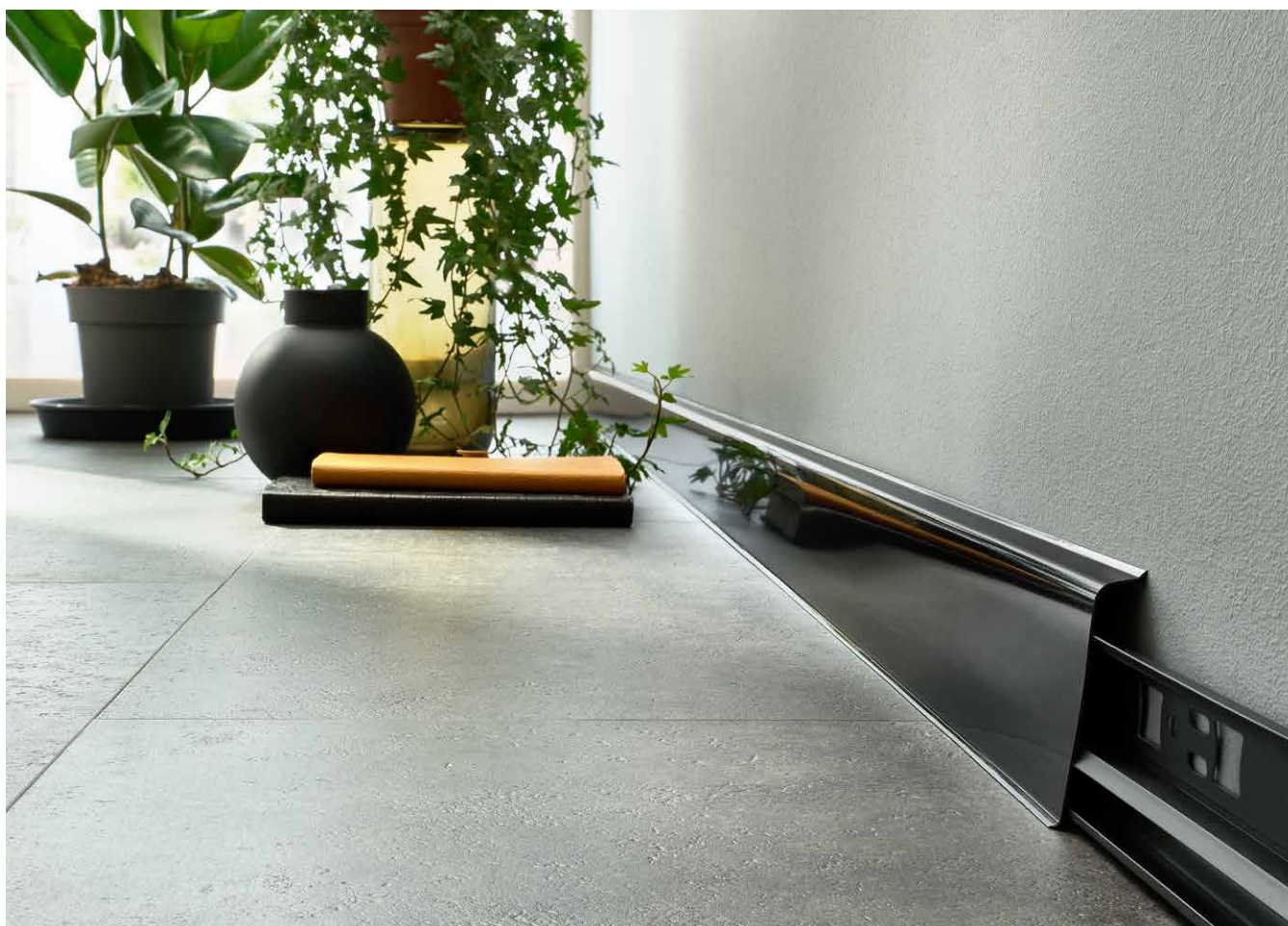

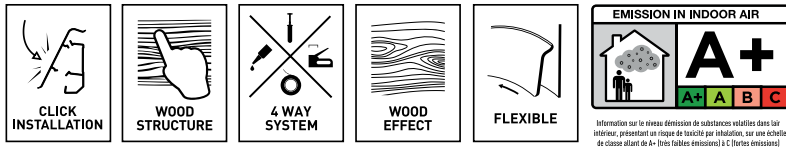

- WOOD STRUCTURE
- CLICK INSTALLATION
- 4 WAY SYSTEM
- WOOD EFFECT
- FLEXIBLE
- EASY WALL RENOVATION
- ECO FRIENDLY

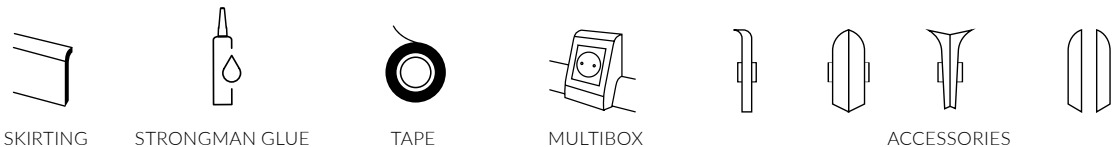
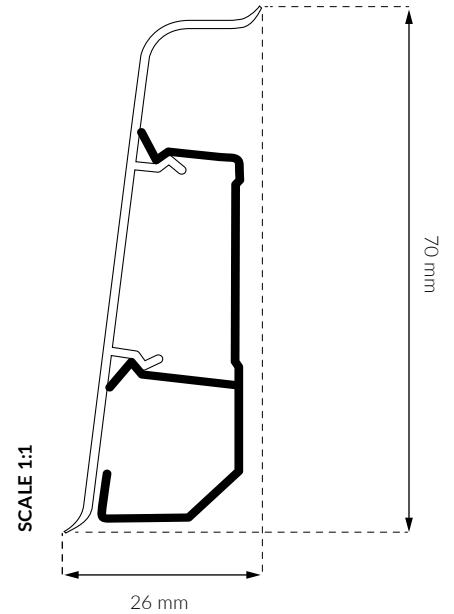

	250 cm	-	-	-	-	-	-	-
	-	1 pc	1 pc	1 pc	2 pcs / 20 pack	2 pcs / 20 pack	2 pcs / 20 pack	1L + 1R 20 L 20 R
	25 m	12 pcs	24 pcs	10 pcs	30 pcs / 1440 pack	30 pcs / 360 pack	30 pcs / 360 pack	30 pcs / 720 pack 30 pcs / 720 pack
EAN		5905167788264	5905167731444	5906735698503				



134 | Cambridge
SKIRTING | 5905167806036



133 | Oxford
SKIRTING | 5905167806029
CS PROFILE | 45



41 | Alu Light
SKIRTING | 5905167781340
CS PROFILE | A1



17 | Aluminium
SKIRTING | 5905167729281



25 | Girona Chestnut
SKIRTING | 5905167781326
CS PROFILE | 19



19 | Ontario Oak
SKIRTING | 5905167755006



44 | Bolton Oak
SKIRTING | 5905167799000
CS PROFILE | 02



23 | Modena Oak
SKIRTING | 5905167755044
CS PROFILE | 23



135 | Platinum Oak
SKIRTING | 5905167806067



112 | Bradford Oak
SKIRTING | 5905167838235



16 | Caucasian Oak
SKIRTING | 5905167725863



20 | Burgos Oak
SKIRTING | 5905167755013
CS PROFILE | 20



131 | Philadelphia Oak
SKIRTING | 5905167806043
CS PROFILE | 46



02 | Northern Ash
SKIRTING | 5905167725726
CS PROFILE | 26



42 | Sand Oak
SKIRTING | 5905167781692
CS PROFILE | 03



04 | Lingburg Oak
SKIRTING | 5905167725740
CS PROFILE | 04



03 | Loft Oak
SKIRTING | 5905167725733
CS PROFILE | 03



138 | Pasadena Oak
SKIRTING | 5905167816998
CS PROFILE | 44



158 | Monument Oak
SKIRTING | 5905167838259
CS PROFILE | 158



153 | Yankee Oak
SKIRTING | 5905167825075



154 | Sierra Oak

SKIRTING | 5905167825082
CS PROFILE | 07



05 | Windston Oak

SKIRTING | 5905167725757
CS PROFILE | 31



110 | Jersey Oak

SKIRTING | 5905167838242



09 | Manorial Oak

SKIRTING | 5905167725795
CS PROFILE | 65



10 | Bourbon Oak

SKIRTING | 5905167725801
CS PROFILE | 09



11 | Holm Oak

SKIRTING | 5905167725818
CS PROFILE | 11



12 | Dark Oak

SKIRTING | 5905167725825
CS PROFILE | 12



140 | Tasmanian Oak

SKIRTING | 5905167817018
CS PROFILE | 49



180 | Alba Oak

SKIRTING | 5905167851500
CS PROFILE | 26



187 | Avalon Oak

SKIRTING | 5905167851517
CS PROFILE | 26



197 | Flamenco Oak

SKIRTING | 5905167851524



198 | Pedro Oak

SKIRTING | 5905167851531
CS PROFILE | 159



199 | Paris Oak

SKIRTING | 5905167851548
CS PROFILE | 159



191 | Kinesawa Oak

SKIRTING | 5905167851555
CS PROFILE | 11



LARS





WOOD STRUCTURE



EASY INSTALLATION





FLEXIBLE

MODERN DESIGN

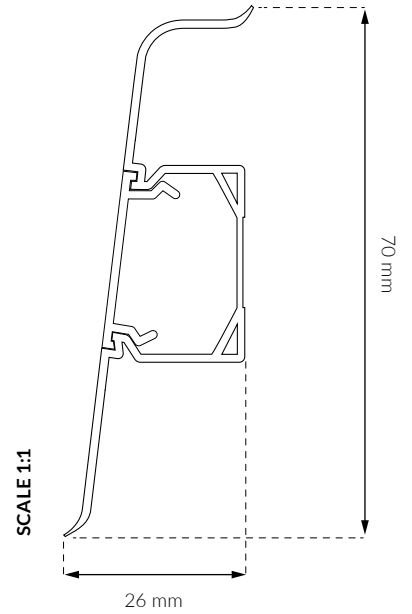
- WOOD STRUCTURE
- EASY INSTALLATION
- FLEXIBLE
- MODERN DESIGN
- ECO FRIENDLY



	SKIRTING	STRONGMAN GLUE	TAPE	MULTIBOX	ACCESSORIES			
 250 cm	-	-	-	-	-	-	-	-
 -	1 pc	1 pc	1 pc	2 pcs / 20 pack	2 pcs / 20 pack	2 pcs / 20 pack	1L + 1R 20 L 20 R	
 50 m	12 pcs	24 pcs	10 pcs	30 pcs / 1440 pack	30 pcs / 360 pack	30 pcs / 360 pack	30 pcs / 720 pack	30 pcs / 720 pack
EAN	5905167788264	5905167731444	5906735698503					



40 | White Mat

SKIRTING | 5905167783504
CS PROFILE | 40



41 | Alu Light

SKIRTING | 5905167817391



25 | Snow Ash

SKIRTING | 5905167783474
CS PROFILE | 29



02 | Winterwood Ash

SKIRTING | 5905167783399
CS PROFILE | 27



44 | Platinum Oak

SKIRTING | 5905167783535



50 | Scandinavian Oak

SKIRTING | 5905167783580
CS PROFILE | 48



04 | Alpine Oak

SKIRTING | 5905167783443
CS PROFILE | 04



45 | Swedish Oak

SKIRTING | 905167783528



42 | Arena Oak

SKIRTING | 5905167783511
CS PROFILE | 03



03 | Norwegian Oak

SKIRTING | 5905167783412
CS PROFILE | 03



47 | Tatra Oak

SKIRTING | 5905167783542



32 | Elegant Oak

SKIRTING | 5905167783498
CS PROFILE | 39



46 | Golden Oak

SKIRTING | 5905167783559
CS PROFILE | 09



09 | Noble Oak

SKIRTING | 5905167783436
CS PROFILE | 29



12 | Brazilian Walnut

SKIRTING | 5905167783450
CS PROFILE | 12



05 | Anderson Oak

SKIRTING | 5905167853740



19 | Windston Oak

SKIRTING | 5905167853757



131 | Philadelphia Oak

SKIRTING | 5905167853764

ACCESSORIES



MACK

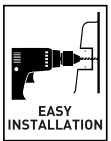

MODERN DESIGN

- MODERN DESIGN
- EASY INSTALLATION
- FLEXIBLE
- ECO FRIENDLY

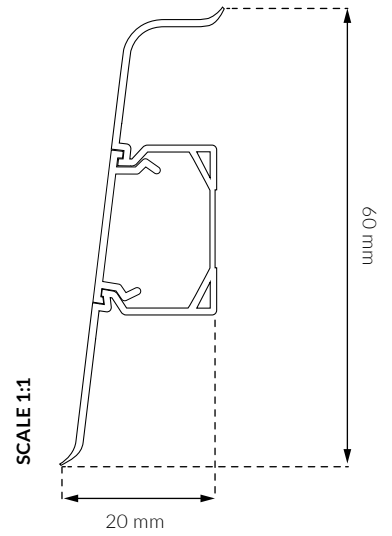

SKIRTING



STRONGMAN GLUE



TAPE



MULTIBOX



ACCESSORIES



EAN

250 cm	-	-	-	-	-	-	-	-
-	1 pc	1 pc	1 pc	2 pcs / 25 pack	2 pcs / 25 pack	2 pcs / 25 pack	1L + 1R 25 L 25 R	
50 m	12 pcs	24 pcs	10 pcs	30 pcs / 1440 pack	30 pcs / 360 pack	30 pcs / 360 pack	30 pcs / 720 pack	30 pcs / 720 pack

5905167788264

5905167731444

5906735698503



401 | White Mat

SKIRTING | 5905167803554
CS PROFILE | 40

NEW



220 | Black Mat

SKIRTING | 5905167853245



41 | Alu Light

SKIRTING | 5905167803721



25 | Girona Chestnut

SKIRTING | 5905167803578
CS PROFILE | 42



107 | Bolton Oak

SKIRTING | 5905167803585
CS PROFILE | 19



135 | Platinum Oak

SKIRTING | 5905167803615



16 | Caucasian Oak

SKIRTING | 5905167803639



02 | North Ash

SKIRTING | 5905167803592
CS PROFILE | 26

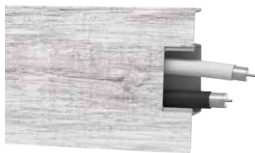

131 | Philadelphia Oak

SKIRTING | 5905167803622
CS PROFILE | 19



42 | Arena Oak

SKIRTING | 5905167803646



03 | Loft Oak

SKIRTING | 5905167803653
CS PROFILE | 03



04 | Lingburg Oak

SKIRTING | 5905167803660
CS PROFILE | 04



136 | Antique Oak

SKIRTING | 5905167803677



86 | Laplant Oak

SKIRTING | 5905167803684



132 | Edmonton Oak

SKIRTING | 5905167803707

NEW



12 | Dark Oak

SKIRTING | 5905167853252

ACCESSORIES



SKIRTING BOARDS

**TRADITIONAL
PVC**
COLLECTIONS





LM60
LM55

TRADITIONAL
PVC

LM60

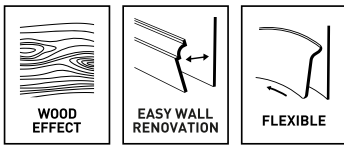

- FLEXIBLE ADAPTATION
- WOOD EFFECT
- ECO FRIENDLY PVC

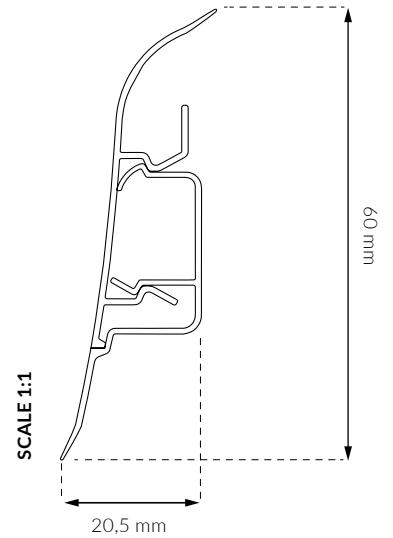

	250 cm	-	-	-	-	-
	-	1 pc	2 pcs / 25 pack	2 pcs / 25 pack	2 pcs / 25 pack	1L + 1R 25 L+25 R 25 L+25 R
	50 m	10 pcs	30 pcs / 1440 pack	30 pcs / 360 pack	30 pcs / 360 pack	30 pcs / 1440 pack 30 pcs / 1440 pack

EAN 5906735698503



34 | White
SKIRTING | 5905167749043



39 | Aluminium
SKIRTING | 5907749020014



107 | Bolton Oak
SKIRTING | 5905167752944



99 | Kendari Oak
SKIRTING | 5905167709542



44 | Golden Oak
SKIRTING | 5907749020083



65 | Canyon Oak
SKIRTING | 5905167662656



77 | Sand Oak
SKIRTING | 5905167662953



52 | Ardennes Oak
SKIRTING | 5907749020311



49 | Liverpool Oak
SKIRTING | 5907749020144



86 | Laplant Oak
SKIRTING | 5907749049282



72 | Bourbon Oak
SKIRTING | 5905167663264



63 | Tosca Oak
SKIRTING | 5905167663349



94 | Victoria Oak
SKIRTING | 5905167703175



97 | Lagos Oak
SKIRTING | 5905167709528

ACCESSORIES

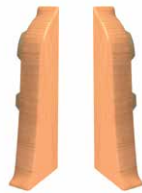

LM55

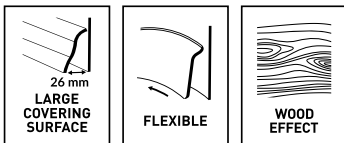

- WOOD EFFECT
- EASY WALL RENOVATION
- FLEXIBLE
- ECO FRIENDLY PVC

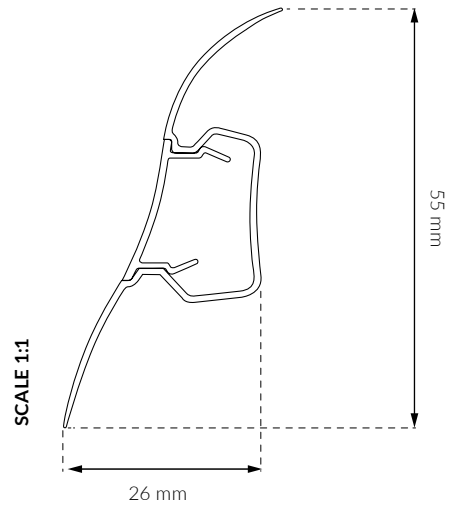

SKIRTING



MULTIBOX



ACCESSORIES

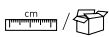

EAN

250 cm	-	-	-	-	-	-
-	1 pc	2 pcs / 25 pack	2 pcs / 25 pack	2 pcs / 25 pack	1L + 1R 25 L+25 R 25 L+25 R	
50 m	10 pcs	30 pcs / 1440 pack	30 pcs / 360 pack	30 pcs / 360 pack	30 pcs / 1440 pack	30 pcs / 1440 pack

5906735698503



101 | White Matt
SKIRTING | 5905167735558



108 | Aspen Oak
SKIRTING | 5905167788349



107 | Girona Chestnut
SKIRTING | 5905167788332



45 | Grey Acacia
SKIRTING | 5907749020236



104 | Sardinia Oak
SKIRTING | 5905167741948



48 | Golden Oak
SKIRTING | 5907749020243



58 | Country Oak
SKIRTING | 5905167662748



103 | Havana Oak
SKIRTING | 5905167741153



77 | Sand Oak
SKIRTING | 5905167734810



47 | Liverpool Oak
SKIRTING | 5907749014853



65 | Canyon Oak
SKIRTING | 5905167662762



102 | Almelo Oak
SKIRTING | 5905167741146



20 | Savoyen Oak
SKIRTING | 5906735647785



28 | Pecan
SKIRTING | 5907749001228



34 | Alaska Oak
SKIRTING | 5907749014716



85 | North Oak
SKIRTING | 5907749049329



67 | Classic Light Oak
SKIRTING | 5905167662885



86 | Laplant Oak
SKIRTING | 5905167670293



83 | Romantic Oak
SKIRTING | 5905167662915



26 | Dark Oak
SKIRTING | 5907749001204

ACCESSORIES

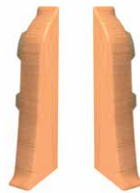

SKIRTING BOARDS

**TRADITIONAL
MDF**
COLLECTIONS

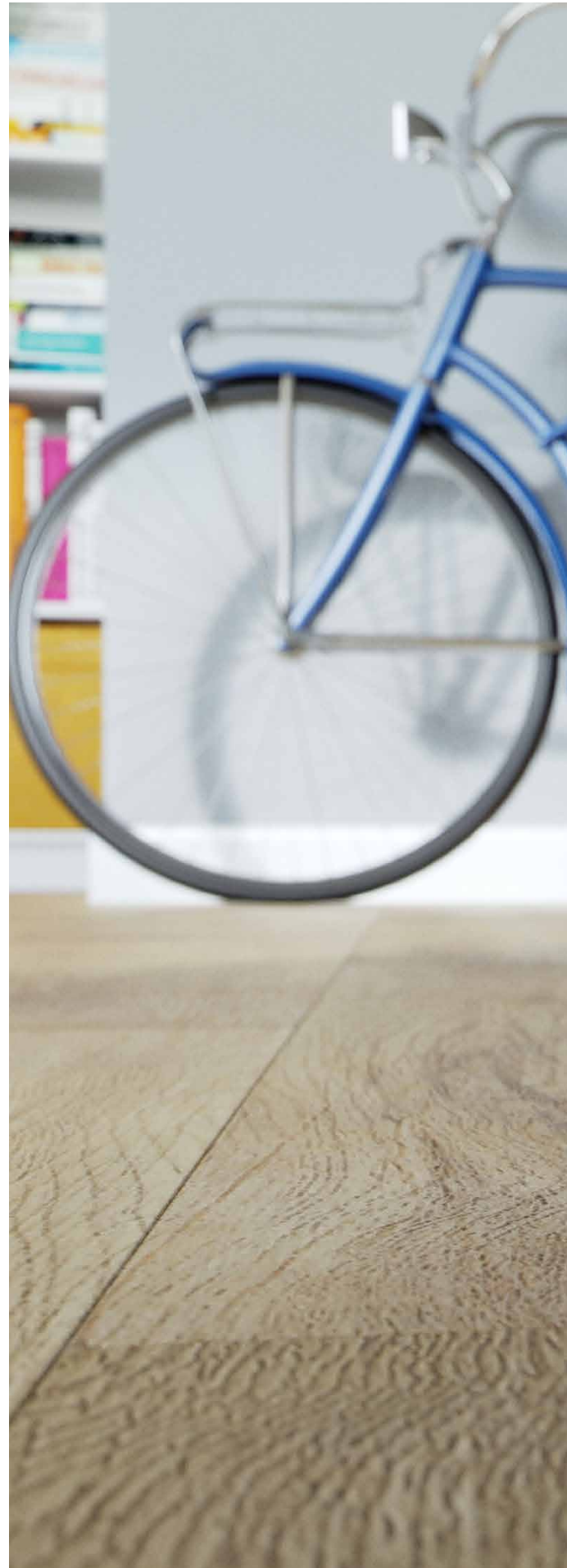









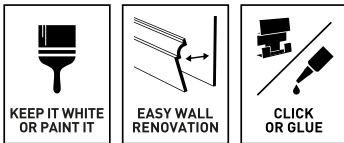

**PAINT IT
DIAMOND**

TRADITIONAL
MDF

PAINT IT



- KEEP IT WHITE OR PAINT IT
- EASY WALL RENOVATION
- CLICK OR GLUE

					
	SKIRTING	BLOCKS	CLIPS AND DOWELS	STRONGMAN GLUE	ACRYLIC
	242 cm	1,8x1,8x11,2 cm	ø 6 mm	-	-
	-	4 pcs = 1 set	25 pcs	1 pc	1 pc
	24,2 m	10 sets	1500 pcs	12 pcs	12 pcs
EAN		5905167736937	5905167674437	5905167788264	5907584890193

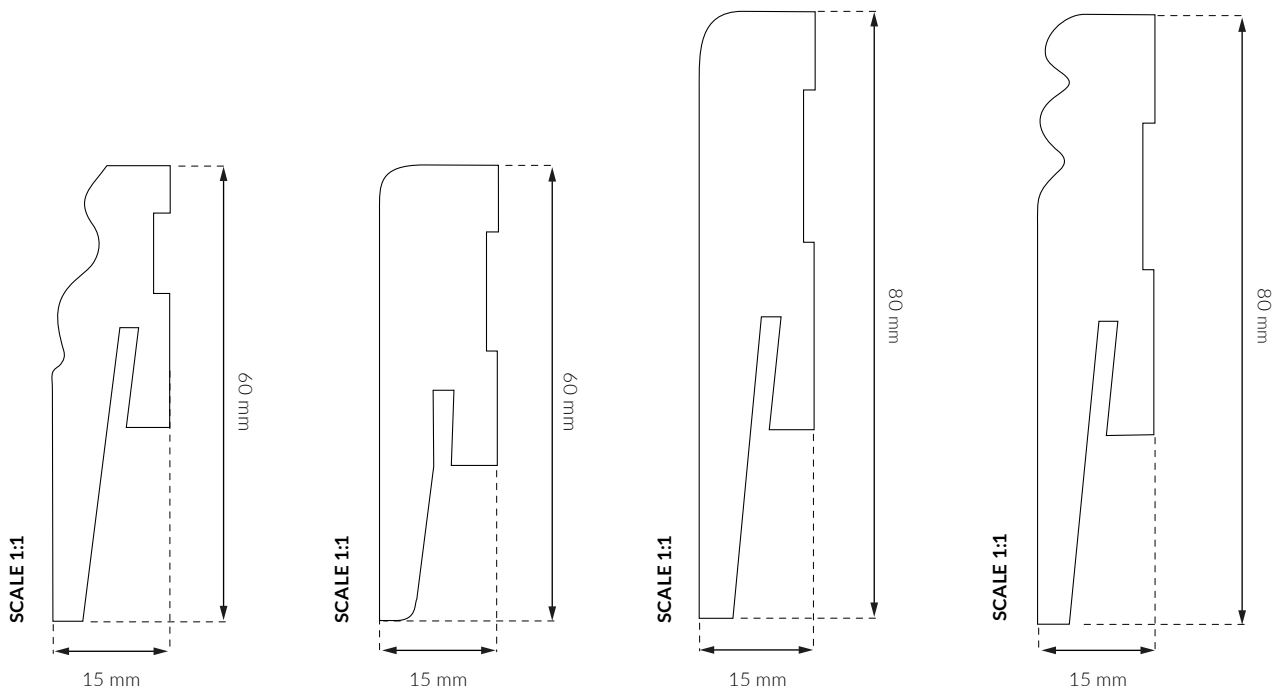

White
MP0601 | 5905167674338
📦 24,2 m



White
MP0602 | 5905167754986
📦 24,2 m



White
MP0801 | 5905167674345
📦 24,2 m



White
MP0802 | 5905167674352
📦 24,2 m

ACCESSORIES / UNIVERSAL BLOCK



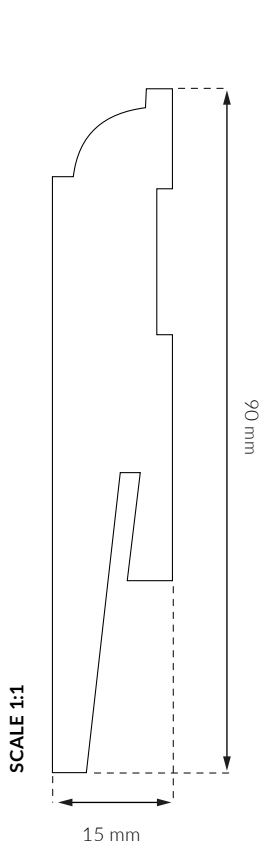

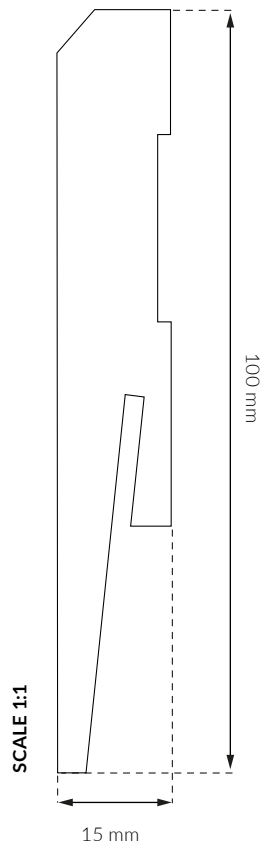

White
 MP0901 | 5905167674369
 24,2 m

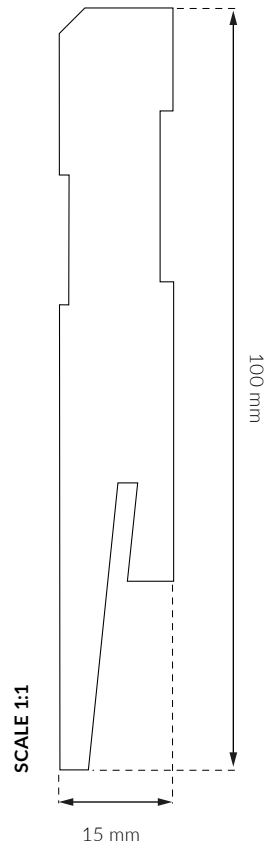

White
 MP1001 | 5905167674376
 24,2 m



White
 MP1002 | 5905167674383
 24,2 m

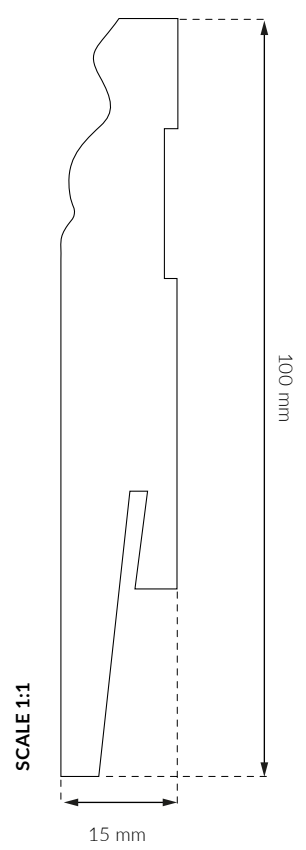

White
 MP1003 | 5905167674390
 24,2 m

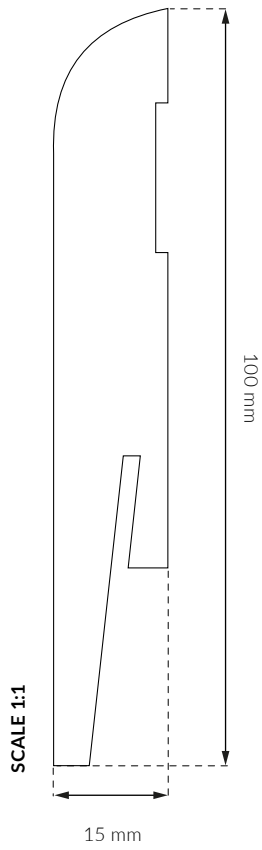

White
 MP1004 | 5905167674406
 24,2 m

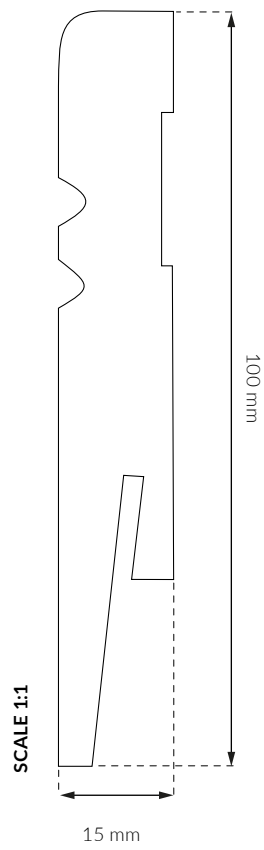

White
 MP1005 | 5905167674413
 24,2 m

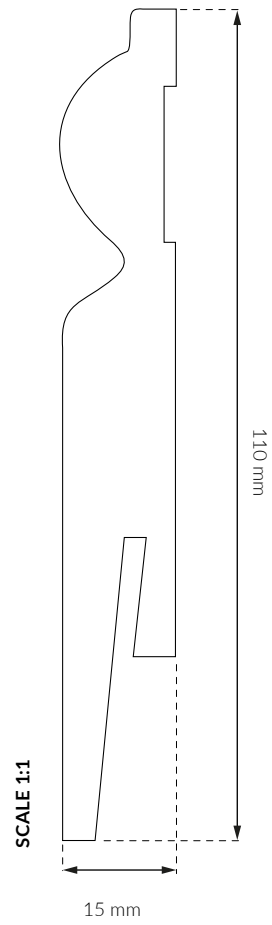

White
 MP1101 | 5905167674420
 24,2 m







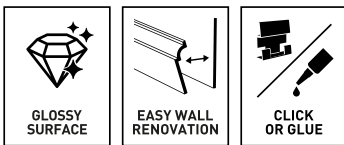

DIAMOND



MDF
NATURAL MATERIALS



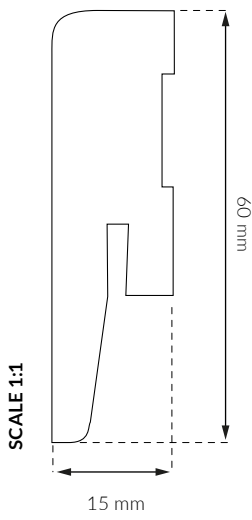

- GLOSSY SURFACE
- EASY WALL RENOVATION
- CLICK OR GLUE

					
	SKIRTING	BLOCKS	CLIPS AND DOWELS	STRONGMAN GLUE	ACRYLIC
	242 cm	1,8x1,8x11,2 cm	ø 6 mm	-	-
	-	4 pcs = 1 set	25 pcs	1 pc	1 pc
	24,2 m	10 sets	1500 pcs	12 pcs	12 pcs
EAN		5905167736937	5905167674437	5905167788264	5907584890193

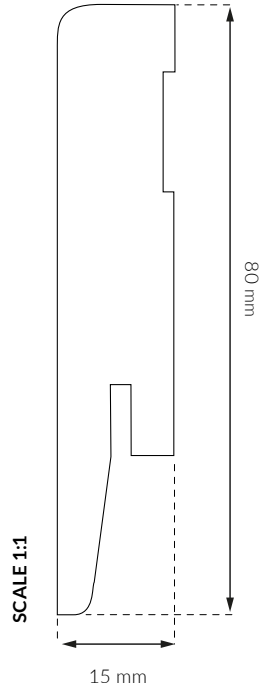

White
 GP0601 | 5905167766668
 21,8 m



White
 GP0801 | 5905167766675
 24 m

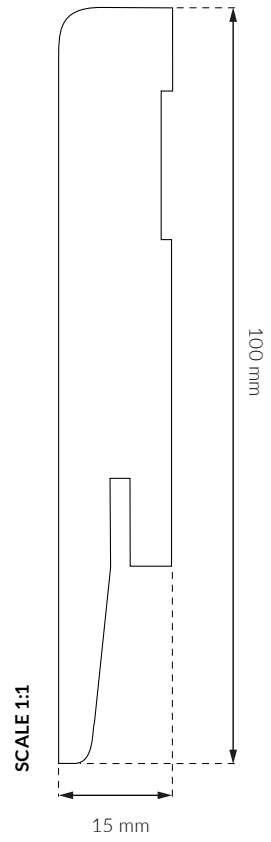

White
 GP1001 | 5905167766682
 24 m

ACCESSORIES / UNIVERSAL BLOCK

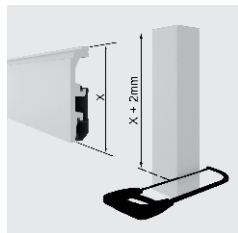
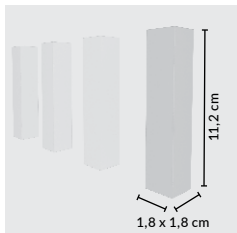

UNIVERSAL PROFILE



00 | Black



01 | White



02 | Beech



08 | Light Oak



11 | Grey Ash

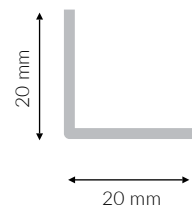
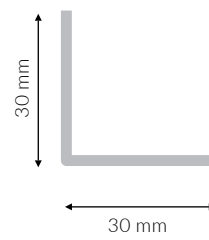
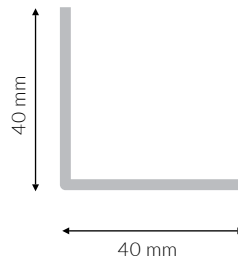
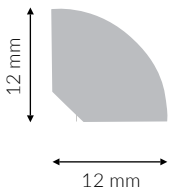

LC

QUARTER ROUND
PROFILE

00	5907584871017
01	5907584871024
02	5907584871055
08	5907584871062
11	5907584871031

LK

ANGLE BARS WITH BOTH SIDES PRINTED



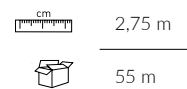
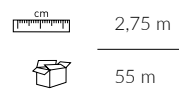
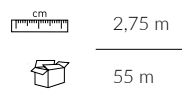
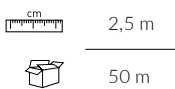

00	5907584871208	00	5907584871307	00	5907584871406
01	5907584871215	01	5907584871314	01	5907584871413
02	5907584871246	02	5907584871345	02	5907584871444
08	5907584871239	08	5907584871338	08	5907584871437
11	5907584871253	11	5907584871352	11	5907584871451

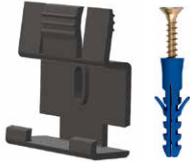

ACCESSORIES







CLIPS AND DOWEL FOR VIGO, MDF COLLECTION

		ø 6 mm
		20 pcs
		1200 pcs
EAN		5905167826737







TAPE

		-
		1 pc
		24 pcs
EAN		5905167731444







STRONGMAN GLUE

		-
		1 pc / 300 ml
		12 pcs
EAN		5905167788264







ACRYL

		-
		1 pc / 300 ml
		12 pcs
EAN		5907584890193



BLOCKS FOR VEGA

		2,3x2,3x15,2 cm
		4 pcs = 1 set
		10 sets
EAN		5905167746844





NEW



CLIPS AND DOWEL FOR STIQ+ 580

		ø 6 mm
		30 pcs
		840 pcs
EAN		5905167839935

BLOCKS FOR MDF

		1,8x1,8x11,2 cm
		4 pcs = 1 set
		10 sets
EAN		5905167736937

SYMBOLS



100% WATERPROOF
Clean your floor without any risk – non-deforming, water resistant board!



FLEXIBLE
Flexible adaptation to uneven walls.



IMPACT RESISTANT
Highest resistance and stability.

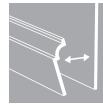

EASY WALL RENOVATION
Possibility of unfixing skirtings in order to paint or hide TV or audio cable (max 230V).



KEEP IT WHITE OR PAINT IT
The board which can be painted. Possibility of fully matching the board colours to the walls of the room.



4 WAY SYSTEM
Solid, fast, simple installation and deinstallation, for any type of wall.



GLOSSY SURFACE
Brilliant shiny finishing.

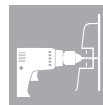

EASY INSTALLATION
Wide installation channel provides an easy access for a drill or screwdriver. It makes installation quicker and easier.



WOOD EFFECT
The ideal colour and design match, 100% accurate representation of wooden colors.



MITRE SAW
The possibility of cutting corners with a mitre saw.



MANUAL CUTTING
The possibility of cutting corners with a hand saw.



DUST AND DIRT BARRIER
Smooth surface without micropores and harder COEX is perfect for easy cleaning and non adhering dirt and dust.



CLICK OR GLUE
Install the skirting in two ways: glue skirting directly to the wall, or clip - strip easily and remove at any time.



MODERN DESIGN
Unique shape was created for a modern interiors and its simplicity is an answer even for the most demanding.



WOOD STRUCTURE
Structure embossed on the surface, perfectly imitating the real wood.



JUST GLUE
Glue skirting directly to the wall.



CLICK INSTALLATION

Proszę o uzupełnienie tekstu z opisem ikony.



ECO FRIENDLY

The board made of environmentally friendly material.



LACQUER

Proszę o uzupełnienie tekstu z opisem ikony.



100% PVC FREE

The board made of environmentally friendly material.



DEEP MATT

Thanks to totally new, multi-step process of production we get a deep matt surface.



MDF

Skirting board made from MDF covered with coated paper which increases durability. It's not necessary to paint the skirting board before the first installation.



SUPER FLEXIBLE

Flexible adaptation to uneven walls.



PATENTED

Our technology is patented



GLUING CHANNEL

special glue channel to prevent the excess of glue from slipping out.



The materials awarded this label comply with very stringent health and environmental requirements.



NO SILICONE NEEDED

Integrated and large rubber edges in the color of the skirting adapts to uneven surfaces and gives a solid connection with the wall and the floor resulting in 100% waterproof barrier



The materials awarded this label comply with very stringent health and environmental requirements.

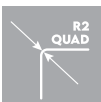

R2 DESIGN = 2mm



HYBRID TECHNOLOGY

The product that combines the advantages of polymer products, like impact resistance and waterproof with high quality surface of lacquered MDF skirtings.



NOTEBOOK

Arbiton

FLOOR EXPERT

Decora S.A.
ul. Prądyńskiego 24a
63-000 Środa Wlkp., Polska
tel.: +48 61 28 64 200
fax: +48 61 28 54 975
e-mail: sales@decora.pl
www.arbiton.com

CHECK OUR COMPLEMENTARY PRODUCTS



UNDERLAYS



FLOOR PROFILES

The catalogue is a free of charge presentation of products of Decora S.A. and acc. to valid law it is not a commercial offer. Colors and textures of the products in pictures may differ from real ones because of limited printing technologies. Decora S.A. reserves its right to alter availability of the products on some markets and at some distributors. The products included in the catalogues do not pose a complete offer of Decora S.A.



VINYL FLOORS

